

Partial Discharge Activities under AC/Impulse Superimposed Voltage in LN₂/Polypropylene Laminated Paper Insulation System for HTS Cables

N Hayakawa¹, R Yamaguchi², Y Ukai², H Kojima¹, F Endo¹, H Okubo²

¹EcoTopia Science Institute, Nagoya University, Nagoya 464-8603, Japan

²Department of Electrical Engineering and Computer Science, Nagoya University,
Nagoya 464-8603, Japan

E-mail: nhayakaw@nuee.nagoya-u.ac.jp

Abstract. This paper discusses electrical insulation characteristics of high temperature superconducting (HTS) cables for their reliable and rational insulation design. We focused on a severe and practical operational condition of HTS cables, i.e. under commercial ac / lightning impulse superimposed voltage. Experimental results for a HTS cable insulation model composed of liquid nitrogen (LN₂) and polypropylene (PP) laminated paper revealed that ac / impulse superimposed voltage could trigger partial discharge (PD) by the impulse voltage invasion and cause consecutive PD under the subsequent ac voltage. The PD generation characteristics were summarized for different ac / impulse superimposed voltages, and a criterion for consecutive PD generation was identified.

1. Introduction

HTS cables have been developed and demonstrated in the world [1]-[4]. The rated voltages of the HTS cables are in the range of 10 kV or 100 kV, where the electrical insulation design should have a decisive role for their reliable operation. However, the electrical insulation techniques at cryogenic temperatures for HTS cables have not yet been established, especially on the electrical insulation characteristics under practical operational condition of HTS cables.

From the above background, we have been investigating the cryogenic electrical insulation techniques mainly for HTS cables. Electrical insulation performance of HTS cables would be deteriorated by partial discharge (PD) under a high electric field stress, which may result in failure, i.e. breakdown (BD). Thus, PD characteristics leading to BD can be regarded as a key factor for reliable and rational insulation design of HTS cables. From this viewpoint, we have recently discussed PD inception, propagation and BD characteristics under ac voltage [5][6], size effect on PD inception strength under ac voltage [7]-[9], PD measurement under lightning impulse voltage [5][8], PD inception characteristics under quench-induced thermal stress condition [10][11].

In this paper, as a possible and practical operational condition of HTS cables, we focused on the lightning surge invasion into HTS cables under commercial ac voltage operation, i.e. ac / impulse superimposed voltage condition. In such a superimposed voltage condition, even if the operating ac voltage of HTS cables is lower than the intrinsic PD inception level, PD would be triggered by the transient impulse voltage and continue under the subsequent ac voltage, which may deteriorate the insulation performance of HTS cables. Experiments and discussions are carried out for a HTS cable insulation model for different ac / impulse superimposed voltages.

2. Experimental setup and procedure

The model electrode has a parallel-plane electrode configuration, as shown in Figure 1, composed of high-voltage electrode moulded with epoxy resin, 3 sheets of polypropylene (PP) laminated paper with each 0.125 mm thickness and grounded electrode. A hole with 5 mm diameter was arranged in the middle layer of PP laminated papers to simulate the butt gap of HTS cables. The model electrode was immersed in liquid nitrogen (LN_2) at atmospheric pressure, and LN_2 / PP laminated paper composite insulation system for HTS cables was constructed. Figure 2 shows the experimental setup for ac / impulse superimposed voltage application to the model electrode. The circuit consists of 60 Hz ac voltage generator, 1.2/50 μs standard lightning impulse voltage generator, a blocking capacitor of 2500 pC and a resistor of 300 k Ω .

Firstly, PD inception voltage (PDIV_{ac}) under ac voltage for the model electrode was measured by a high-frequency CT at the voltage increase rate of 1 kVrms/s. Next, PD inception voltage (PDIV_{imp}) under positive standard lightning impulse voltage was measured by the same CT with a high-pass filter at the voltage increase step of 3 kV. PDIV measurement was repeated for 5-10 times, and the average value of PDIV_{ac} and PDIV_{imp} was evaluated. Then, the synthetic test under ac / impulse superimposed voltage was carried out. Under a continuous ac voltage application, an impulse voltage was applied to the model electrode at an arbitrary phase ϕ of the ac voltage. The applied ac voltage V_{ac} was set to be lower than PDIV_{ac} and the applied impulse voltage V_{imp} was around PDIV_{imp} , i.e. no PD signal was detected under ac voltage before the impulse voltage application. PD generation characteristics under the subsequent ac voltage after the impulse voltage application were measured by the CT. The PD detection sensitivity under ac voltage was 20 pC.

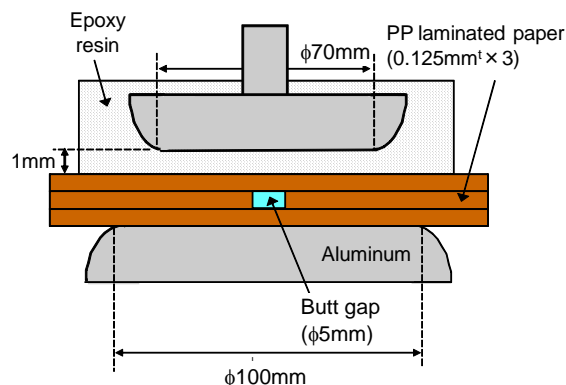

Figure 1 Model electrode

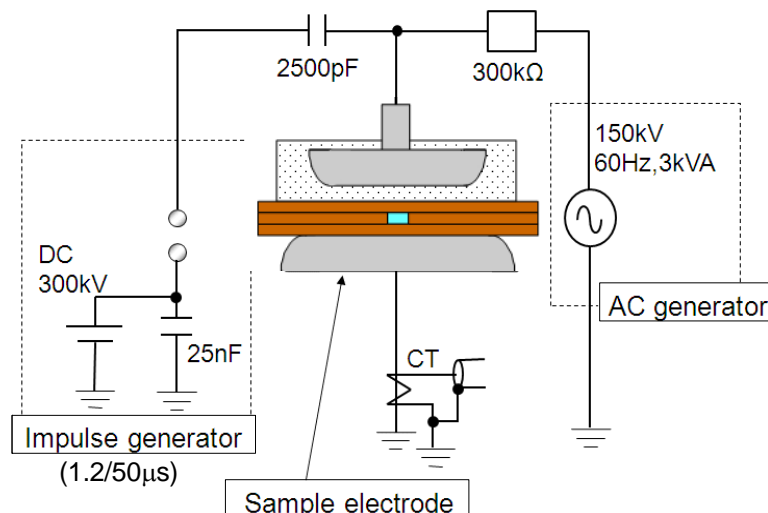

Figure 2 Experimental setup for ac / impulse superimposed voltage application

3. Experimental results

According to the preliminary tests, $PDIV_{ac}$ was 42 kV_{peak} and $PDIV_{imp}$ was 62 kV_{peak} , respectively, for the model electrode. Figure 3 shows an example of ac and impulse voltage waveforms at $V_{ac}=37 \text{ kV}_{peak}$ ($=88\%$ of $PDIV_{ac}$), $V_{imp}=63 \text{ kV}_{peak}$ ($=102\%$ of $PDIV_{imp}$) and $\phi=64$ deg, i.e. the instantaneous ac voltage $V_{i(ac)}=33 \text{ kV}_{peak}$. Figures 4 and 5(a) shows the PD generation characteristics for the ac / impulse superimposed voltage in Figure 3. PD current signal was not detected under ac voltage before the impulse voltage application at $t=0$ s, but detected and activated after $t=20$ ms under the subsequent ac voltage after the impulse voltage application, and disappeared at $t=2.2$ s ($=t_{PD}$) in Figure 5(a). Figure 5(b) shows another example at $V_{ac}=38 \text{ kV}_{peak}$ ($=90\%$ of $PDIV_{ac}$), $V_{imp}=70 \text{ kV}_{peak}$ ($=113\%$ of $PDIV_{ac}$), $\phi=71$ deg and $V_{i(ac)}=36 \text{ kV}_{peak}$. The larger PD current and the longer PD duration t_{PD} for 5.9 s were observed.

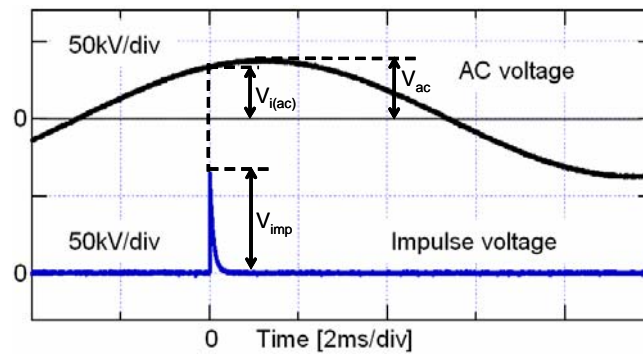

Figure 3 ac and impulse voltage waveform ($V_{ac}=37 \text{ kV}_{peak}$, $V_{imp}=63 \text{ kV}_{peak}$, $V_{i(ac)}=33 \text{ kV}_{peak}$)

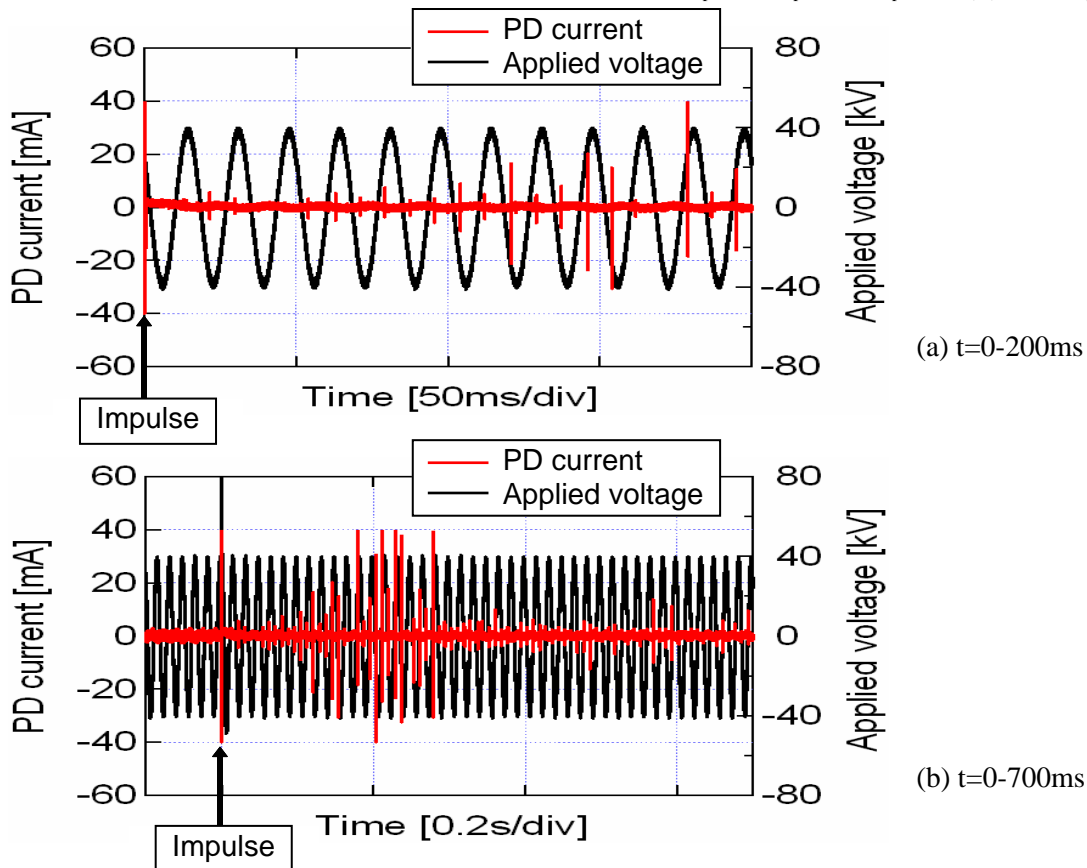

Figure 4 PD generation characteristics for the ac / impulse superimposed voltage ($V_{ac}=37 \text{ kV}_{peak}$, $V_{imp}=63 \text{ kV}_{peak}$, $V_{i(ac)}=33 \text{ kV}_{peak}$)

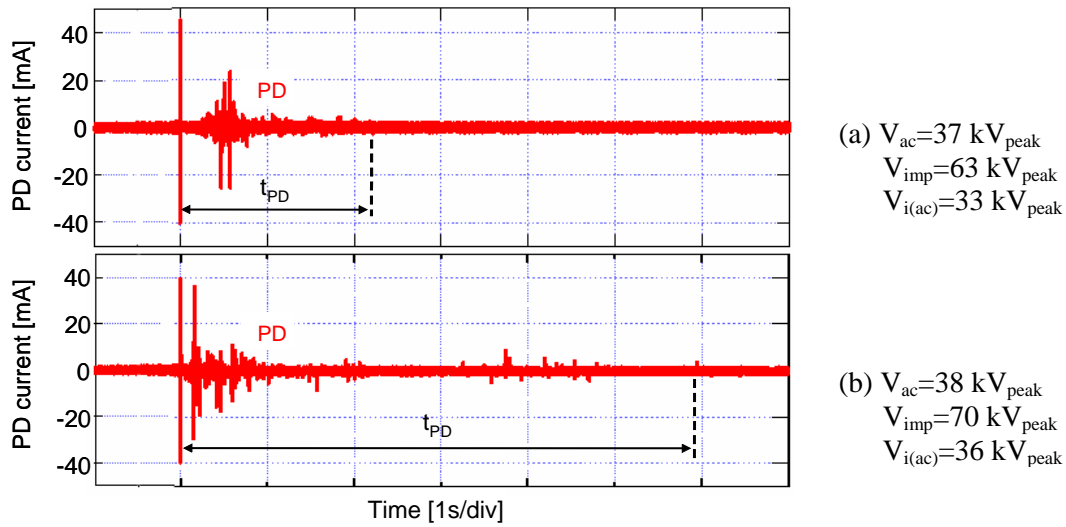

Figure 5 PD generation characteristics for different ac / impulse superimposed voltage conditions

Such PD activity under ac / impulse superimposed voltage can be explained as follows: The impulse voltage V_{imp} nearly equal to $PDIV_{imp}$, depending on the application phase on ac voltage, could trigger the first PD in LN₂ / PP laminated paper composite insulation system of the model electrode. The thermal energy of the first PD would induce bubbles in LN₂, which can generate another consecutive PDs and bubbles. When the bubbles could be cooled and liquefied by the surrounding LN₂, PD signals would be disappeared. The higher voltage stresses would bring about the larger thermal energy of PD, the more bubbles and the longer PD duration.

4. Discussions

The synthetic test under ac / impulse superimposed voltage was repeated for different combinations of V_{ac} , V_{imp} and ϕ or $V_{i(ac)}$. As for the PD activity under ac / impulse superimposed voltage, the instantaneous voltage $V_{i(ac)}+V_{imp}$ at the impulse voltage application can be regarded as the trigger stress for PD inception, whereas the ac voltage V_{ac} can be the steady stress for consecutive ac PD generation. Figure 6 summarizes the PD generation characteristics as a parameter of $V_{i(ac)}+V_{imp}$ as the trigger stress and V_{ac} as the steady stress, where the case with consecutive ac PD triggered is designated by ● and the case with no PD is denoted by ×. The consecutive ac PD was generated in the region with the higher trigger stress and the higher steady stress levels.

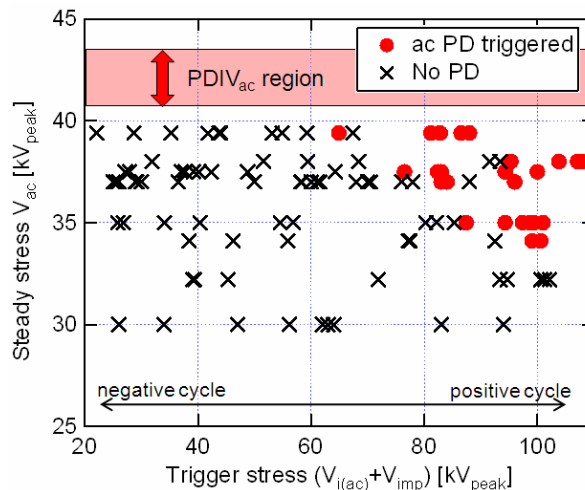

Figure 6 PD generation characteristics as a parameter of trigger stress and steady stress

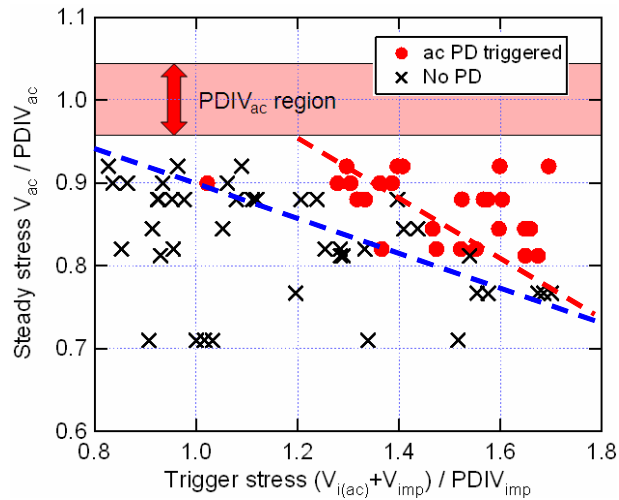

Figure 7 PD generation characteristics as a parameter of normalized trigger stress and steady stress

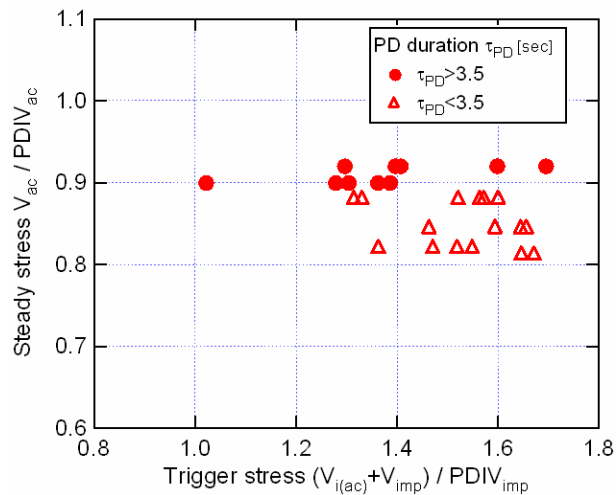

Figure 8 PD duration characteristics as a parameter of normalized trigger stress and steady stress

Here, because the PD generation characteristics are closely related to the PD inception level, the parameters in Figure 6 were normalized by $PDIV_{imp}$ and $PDIV_{ac}$, respectively, as shown in Figure 7. A criterion for consecutive PD generation can be identified by the dotted lines. The consecutive PD was always generated in the highly stressed region above the upper (red) dotted line, occasionally induced in the intermediate region between the upper and the lower (blue) dotted lines, and never occurred in the region below the lower dotted line. Figure 8 shows the PD duration t_{PD} summarized in terms of the same normalized parameters as those in Figure 7. t_{PD} tends to become longer at the normalized steady stress $V_{ac} / PDIV_{ac} > 0.9$, which suggests that t_{PD} depends on the subsequent ac voltage V_{ac} as the steady stress rather than the instantaneous voltage $V_{i(ac)} + V_{imp}$ as the trigger stress.

5. Conclusions

We investigated the PD generation characteristics of LN_2 / PP laminated paper composite insulation system for HTS cables under ac / impulse superimposed voltage as a severe and practical operational condition of HTS cables. The main results in this paper can be summarized as follows:

1. Consecutive PD could be triggered by a lightning impulse voltage application under ac voltage lower than the intrinsic PD inception voltage.

2. A criterion for consecutive PD generation under ac / impulse superimposed voltage was identified as parameters of the instantaneous voltage at the impulse voltage application and the subsequent ac voltage.
3. PD duration depended on the subsequent ac voltage as the steady stress rather than the instantaneous voltage as the trigger stress.

The above evaluation and criterion for consecutive PD generation under ac / impulse superimposed voltage can be reflected to the operational voltage stress of HTS cables, which would contribute to the reliable and rational insulation design of HTS cables.

Acknowledgement

This work was supported by the Grant-in-Aid for Scientific Research (B) of the Ministry of Education, Culture, Sports, Science and Technology, Japan.

References

- [1] J.F.Maguire et al., 2009 *IEEE Trans. on Appl. Supercond.* **19** 1692-1697
- [2] H.Yumura et al., 2009 *IEEE Trans. on Appl. Supercond.* **19** 1698-1701
- [3] J.A.Demko et al., 2007 *IEEE Trans. on Appl. Supercond.* **17** 2047-2050
- [4] S.Mukoyama et al., 2005 *IEEE Trans. on Appl. Supercond.* **15** 1763-1766
- [5] H.Okubo et al., 2006 *IEEE Trans. on Dielectr. and Electr. Insul.* **13** 664-669
- [6] H.Okubo et al., 2008 *IEEE Trans. on Dielectr. and Electr. Insul.* **15** 647-654
- [7] N.Hayakawa et al., 2005 *IEEE Trans. on Dielectr. and Electr. Insul.* **12** 166-174
- [8] N.Hayakawa et al., 2005 *IEEE Trans. on Appl. Supercond.* **15** 1802-1805
- [9] N.Hayakawa et al., 2008 *Int. Conf. on Dielectric Liquids* S4p-04
- [10] N.Hayakawa et al., 2007 *IEEE Trans. on Appl. Supercond.* **17** 1660-1663
- [11] N.Hayakawa et al., 2008 *J.Physics: Conference Series* **97** 12053